

Slatwall Cube Unit Assembly Instructions

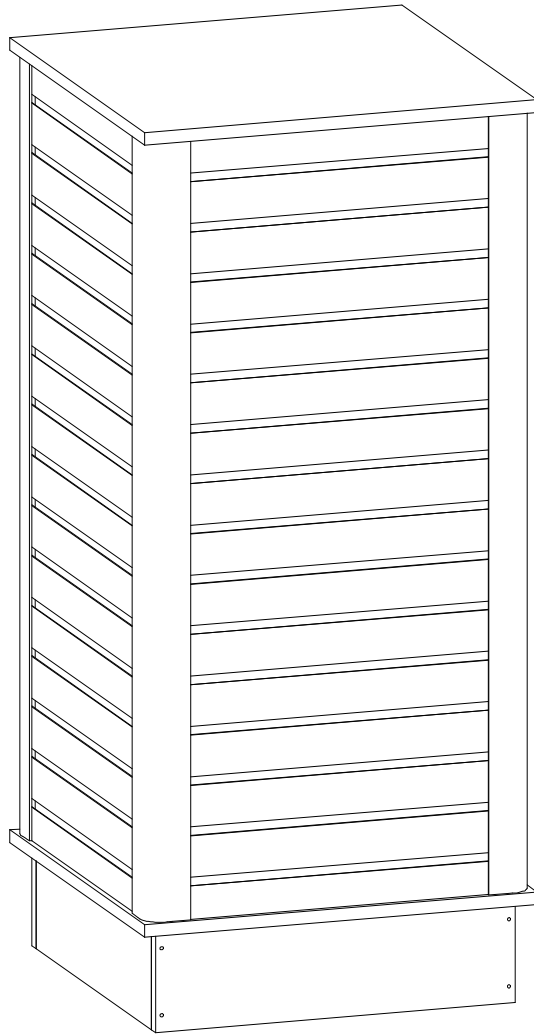

COMPONENTS	
Part #	Qty
1	1
2	4
3	1
4	4
5	4

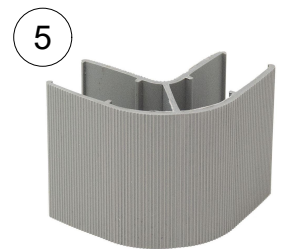
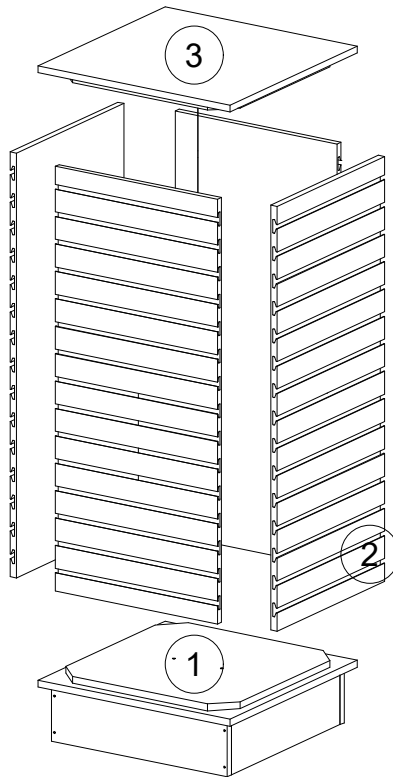

Slatwall Cube Unit Assembly Instructions

Step 1

Turn the Base on its top. Insert the Legs with Levelers into the threaded hole in Bracket, which is already attached to the Base. Set Base aside.

Note:

If using casters, do not install leveling legs. Thread caster directly into the bracket.

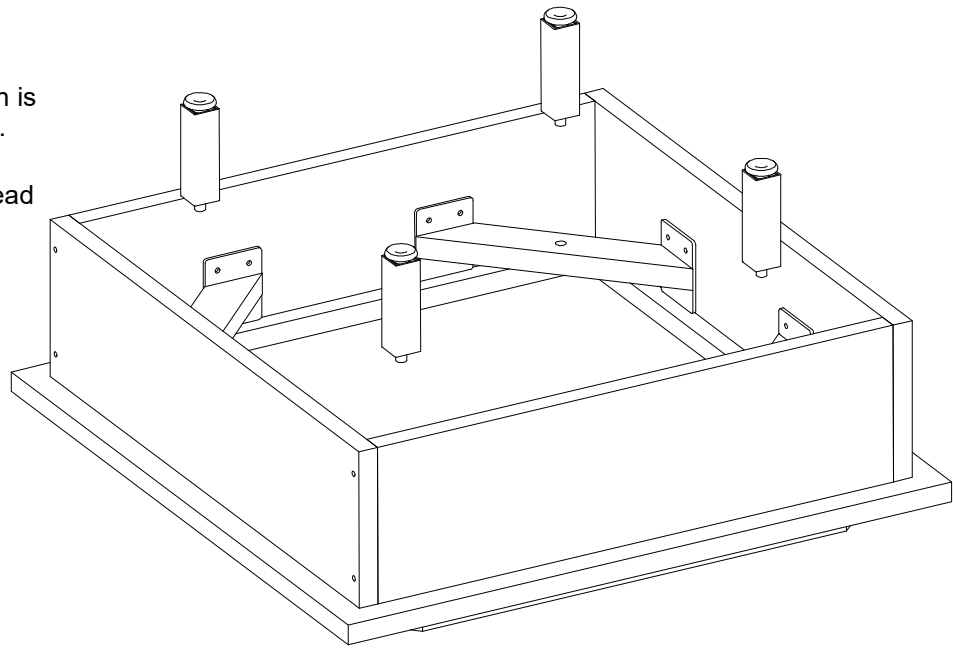

Step 2

Assemble the Cube by snapping the Corner Forms on the long edge of the Slatwall Panels. Connect them forming a square (Fig. 1). Be sure that the Slatwall grooves are facing out.

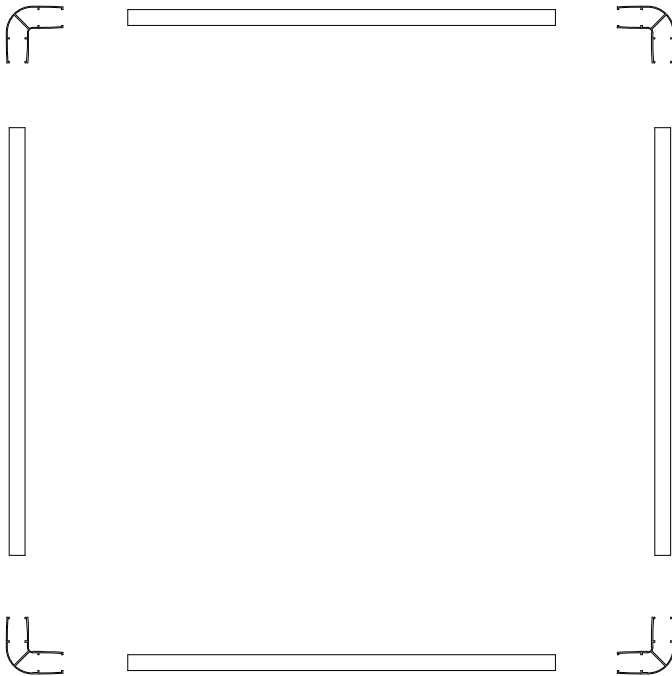
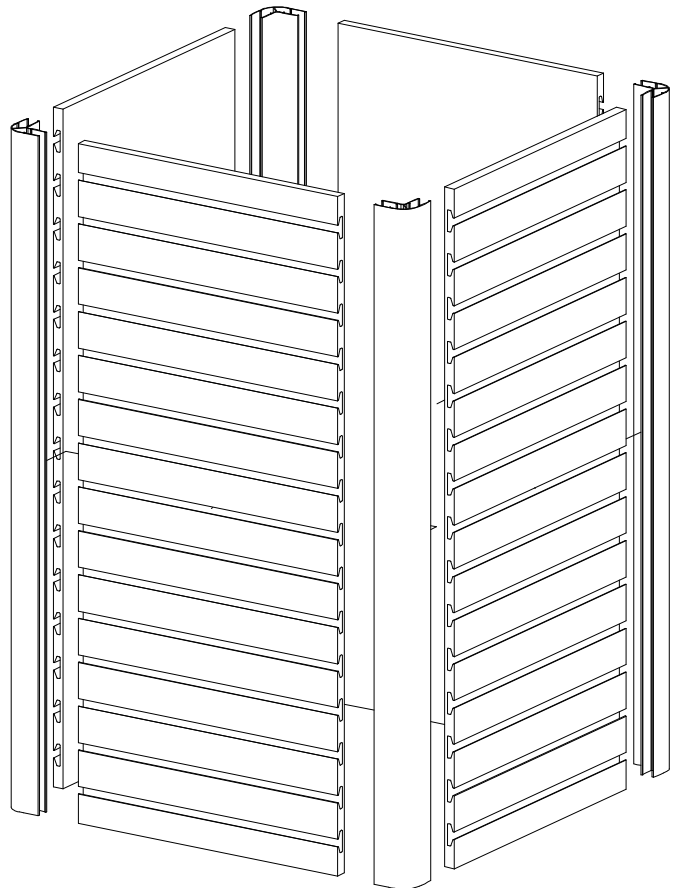

Fig. 1



Slatwall Cube Unit Assembly Instructions

Step 3

Turn the Base over so that it is sitting on the Levelers.

Observe how the Base sits on the floor. If any of the Levelers are not touching the floor, reach under the Base and turn the Leveler(s) in the leg(s) until the Base is able to sit firmly on the floor. Set the Slatwall Cube onto the Base ensuring that the Cube surrounds the cleat on the Base.

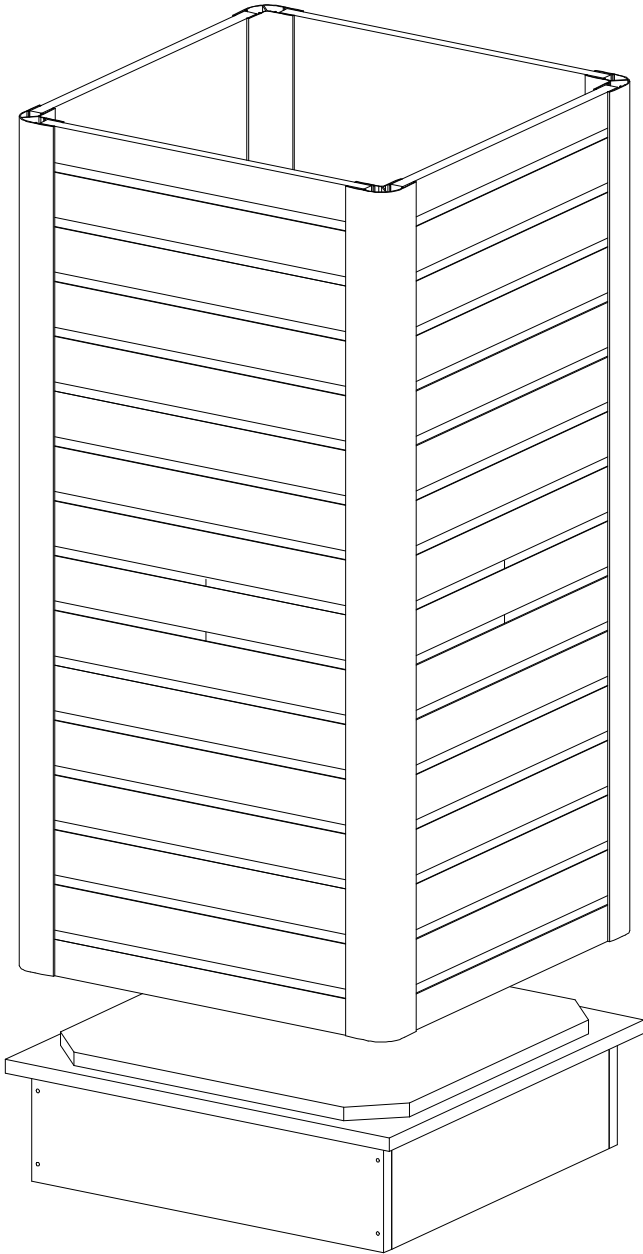

Step 4

Set the top onto the Slatwall Cube ensuring that the Cube surrounds the cleat on the Top.

